

Efektívne laius: **1150 mm**

Laius: **1216 mm**

Mooduli pikkus: **350 mm**

Max soovitatav lehe **5750 mm**  
pikkus:

Pleki paksus: **0,5 mm**

Profiili kõrgus: **33,5 mm**

Ülekatte pikkus: **15 mm**

Kaal: **ca 4,5 kg/m<sup>2</sup>**

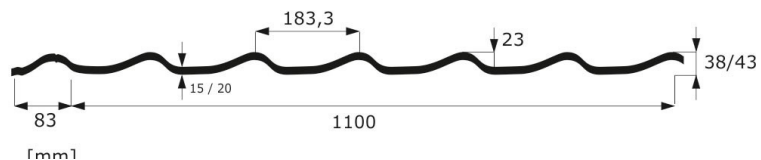

Efektívne laius: **1100 mm**

Laius: **1183 mm**

Mooduli pikkus: **350 / 400 mm**

Max soovitatav lehe **6110 mm**  
pikkus:

Pleki paksus: **0,5 mm**

Profiili kõrgus: **43 mm**

Ülekatte pikkus: **20 mm**

Kaal: **~5 kg**

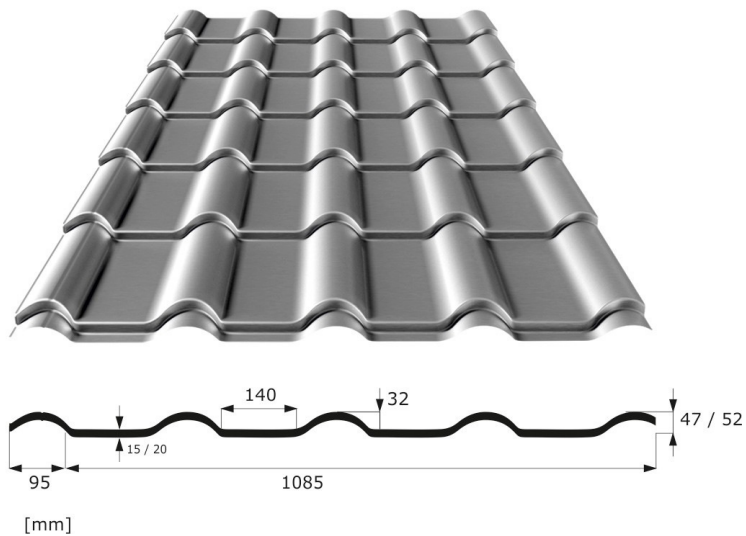

Efektívne laius: **1085 mm**

Laius: **1180 mm**

Mooduli pikkus: **350 / 400 mm**

Max soovitatav lehe **5750 mm**  
pikkus:

Pleki paksus: **0,5 mm**

Profiili kõrgus: **47 / 52 mm**

Ülekatte pikkus: **15 / 20 mm**

Kaal: **~5 kg/m<sup>2</sup>**

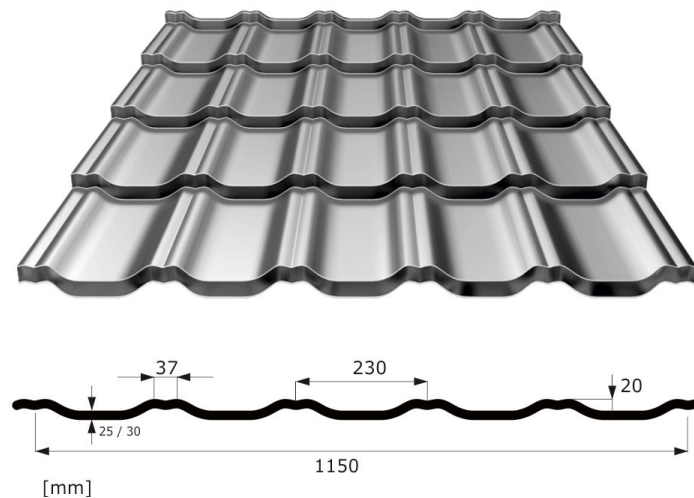

Efektívne laius: **1150 mm**

Laius: **1212 mm**

Mooduli pikkus: **350 / 400 mm**

Max soovitatav lehe **6020 mm**  
pikkus:

Pleki paksus: **0,5 mm**

Profiili kõrgus: **45 / 50 mm**

Ülekatte pikkus: **25 / 30 mm**

Kaal: **~4,5 kg**

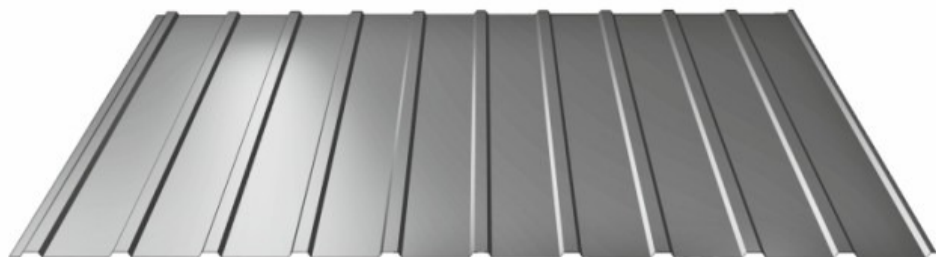

Roof version

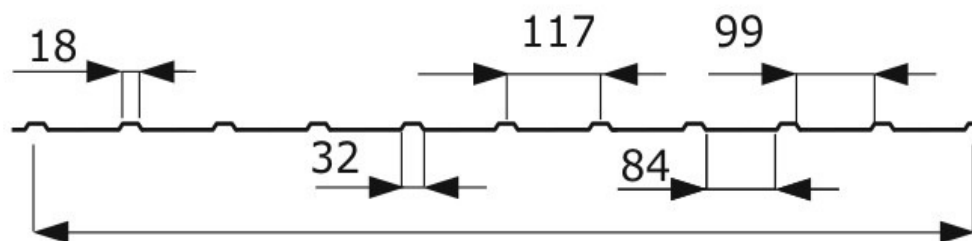

Effective width 1177

**T 7**



Façade version

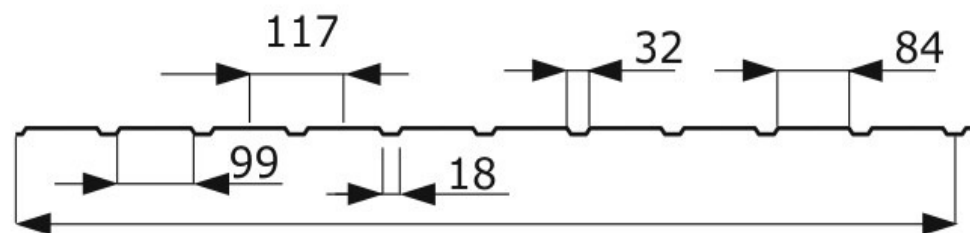

Effective width 1177

Efektīvnē laius: **1177 mm**

Laius: **~1210 mm**

Max soovitatav lehe **6 000 mm**

pikkus:

Pleki paksus: **0,5 - 1,0 mm**

Profiili kõrgus: **7 mm**

C1

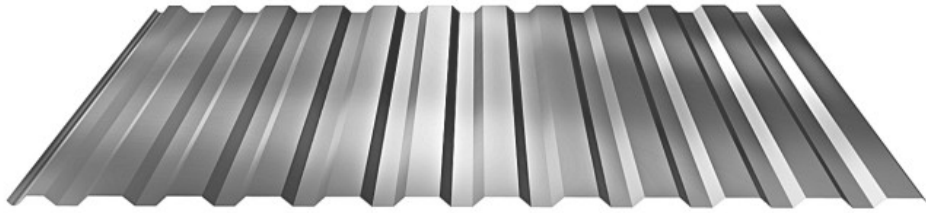

Roof version

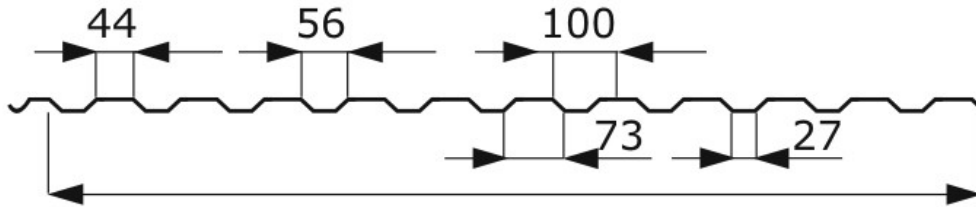

Effective width 1100

**T14**

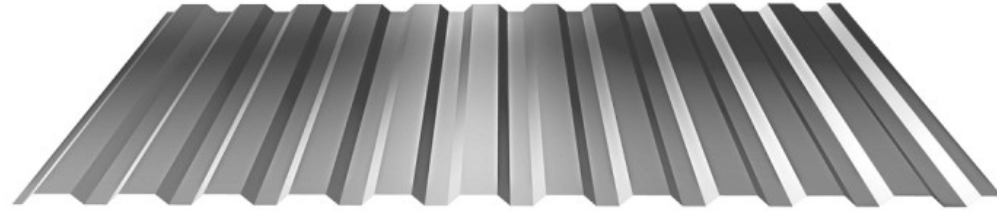

Façade version

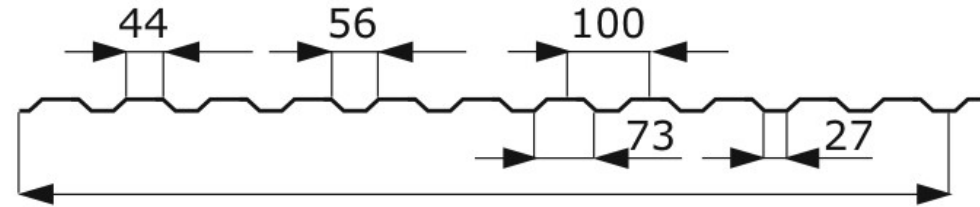

Effective width 1100

Efektīvnē laius: **1100 mm**

Laius: **~1140 mm**

Max soovitatav lehe **8 000 mm**

pikkus:

Pleki paksus: **0,5 - 0,6 mm**

Profiili kõrgus: **12 mm**

## Slide 5

---

C1

Carmee; 04.05.2017

T18

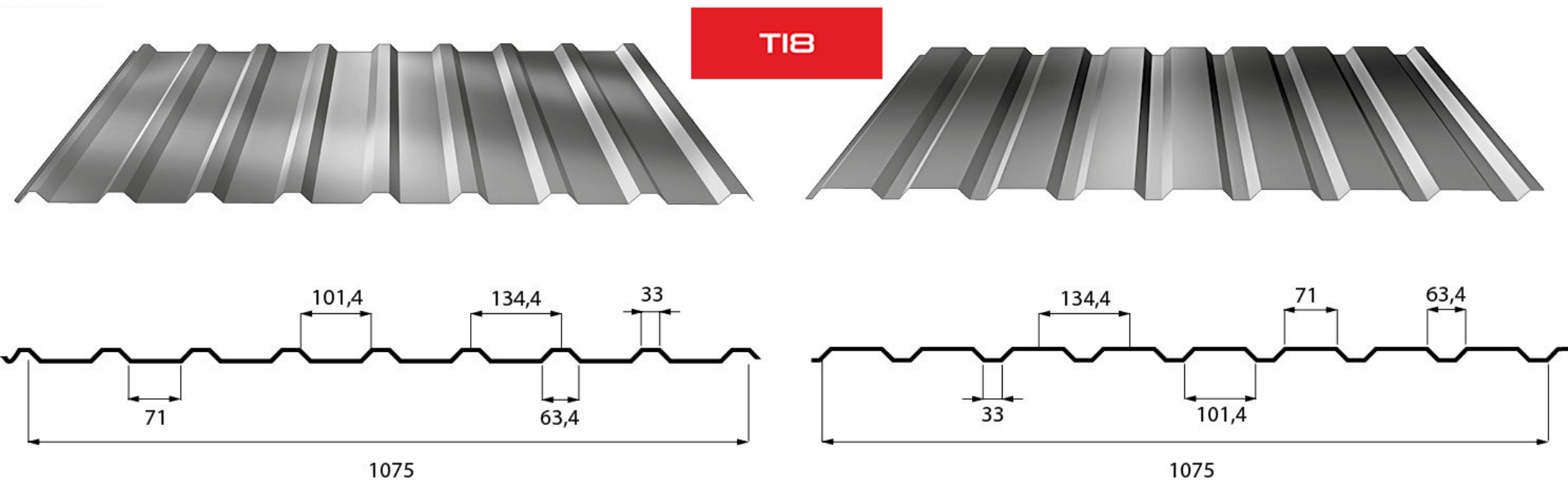

Efektīvnē laius: **1075 mm**

Laius: **~1125 mm**

Max soovitatav lehe **8000 mm**  
pikkus:

Pleki paksus: **0,5-0,75 mm**

Profiili kõrgus: **17,3 mm**

**T18 ECO**

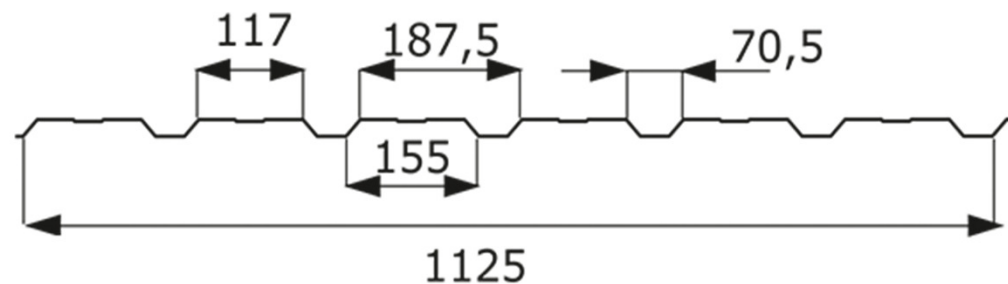
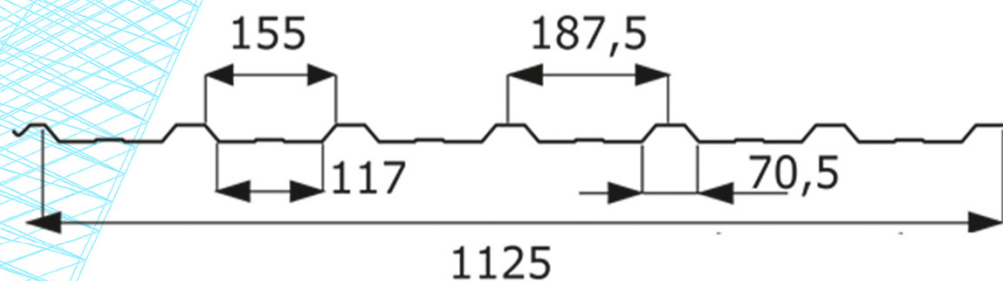
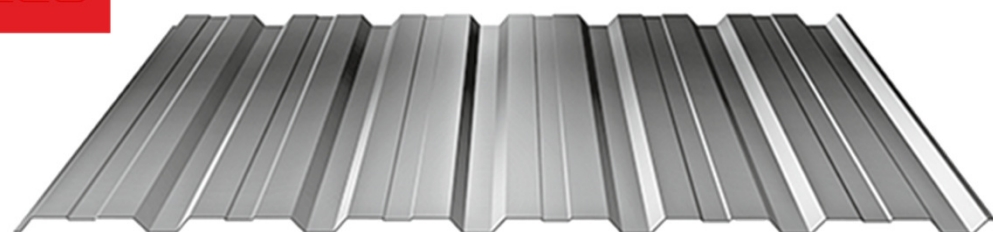
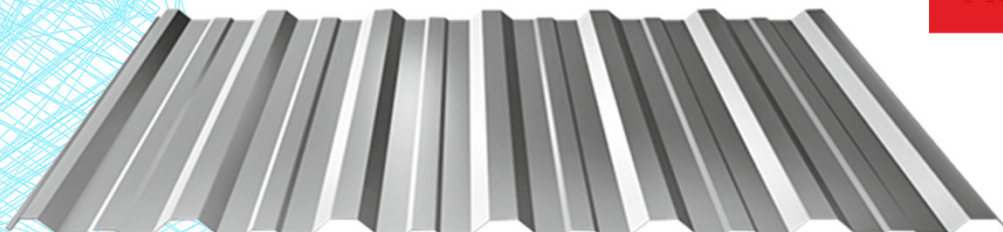

Efektīvnē laius: **1125 mm**

Laius: **~1173 mm**

Max soovitatav lehe **12 000 mm**  
pikkus:

Pleki paksus: **0,5 - 0,75 mm**

Profiili kõrgus: **17 mm**

**T35**

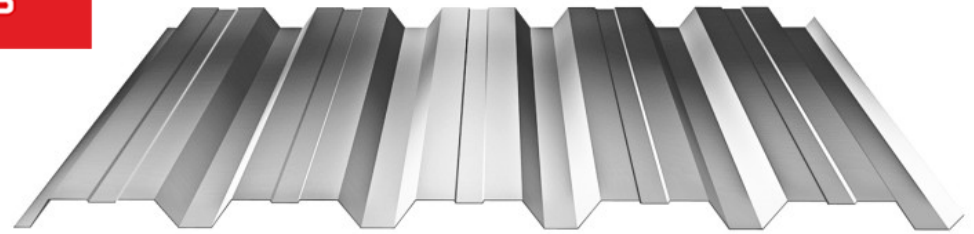
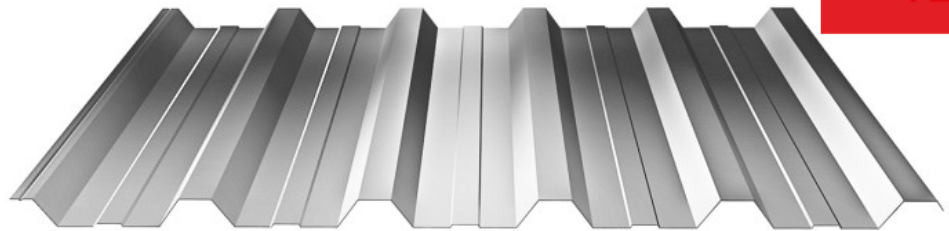

Roof version

Façade version

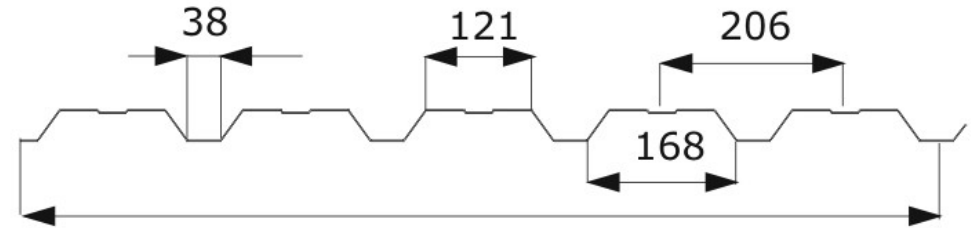
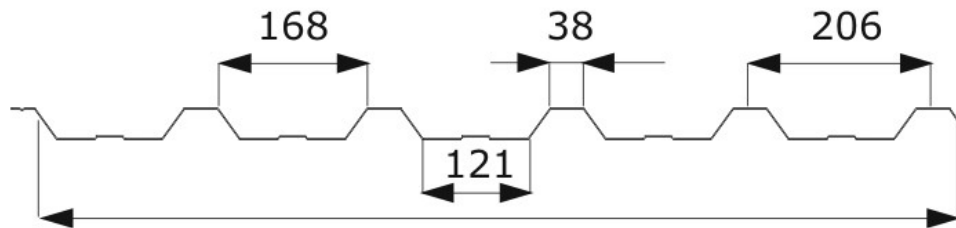

Effective width 1035

Effective width 1035

Efektīvnē laius: **1035 mm**

Laius: **~1070 mm**

Max soovitatav lehe **12 000mm**  
pikkus:

Pleki paksus: **0,5 - 1,0 mm**

Profili kõrgus: **34 mm**

**T35 ECO**



Roof version

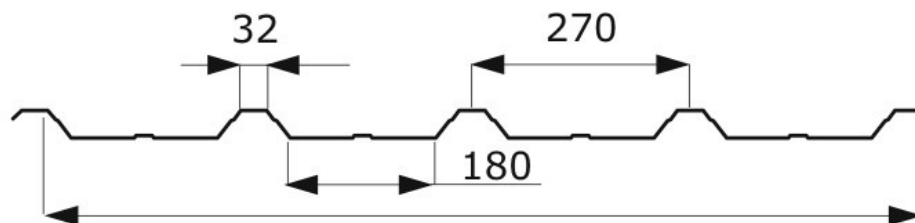

Effective width 1080



Façade version

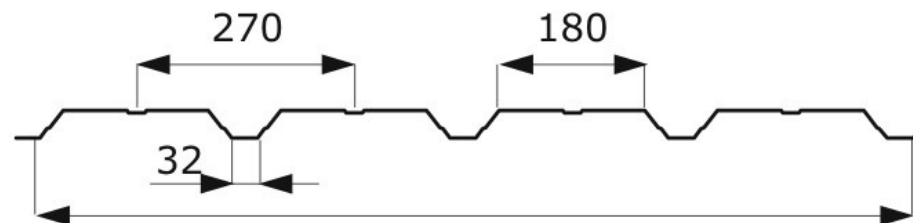

Effective width 1080

Efektīvnē laius: **1080 mm**

Laius: **~1120 mm**

Max soovitav lehe **12 000 mm**  
pikkus:

Paksus: **0,5 - 1,0 mm**

Profiili kõrgus: **34 mm**

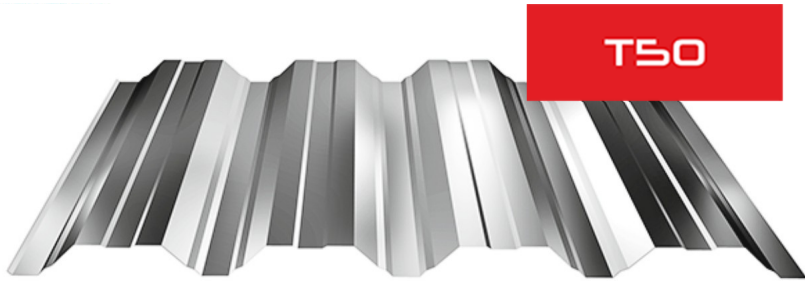

**T50**

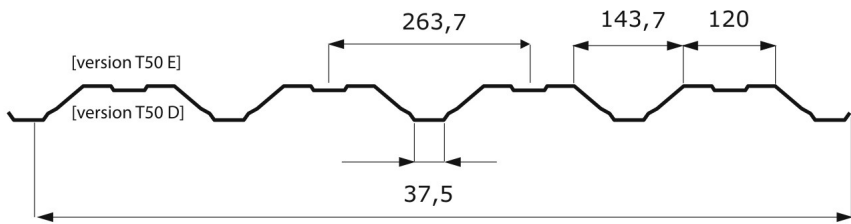

Effective width 1055

Efektīvnē laius: **1055 mm**

Laius: **~1100 mm**

Max soovitatav lehe **12 000 mm**  
pikkus:

Pleki paksus: **0,5 - 1,0 mm**

Profiili kõrgus: **47 mm**



**T55**

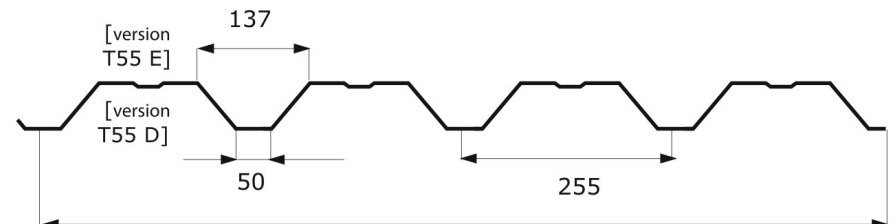

Effective width 1020

Efektīvnē laius: **1020 mm**

Laius: **~1054 mm**

Max soovitatav lehe **12 000 mm**  
pikkus:

Pleki paksus: **0,5 - 1,0 mm**

Profiili kõrgus: **53 mm**

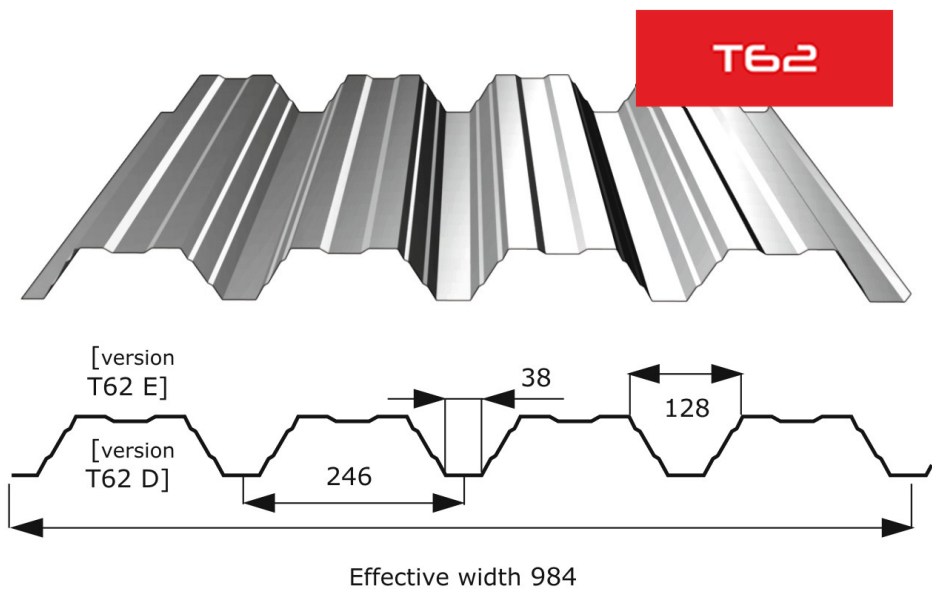

Efektīvnā platumā: **984 mm**

Platumā: **~1015 mm**

Maximālā ieteicamā lapa **12 000 mm**  
garumā:

Plāksnes biezums: **0,6 - 1,25 mm**

Profilu augstums: **61 mm**

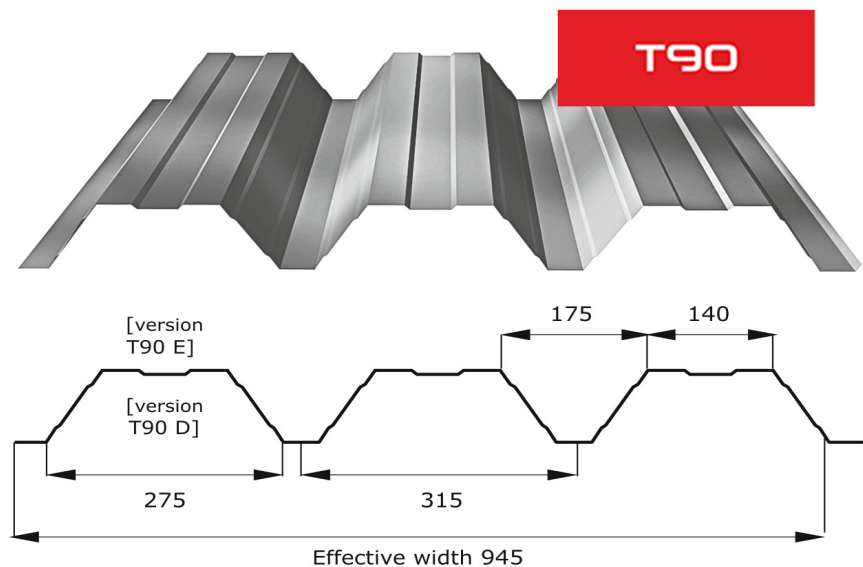

Efektīvnā platumā: **945 mm**

Platumā: **~985 mm**

Maximālā ieteicamā lapa **12 000 mm**  
garumā:

Plāksnes biezums: **0,6 - 1,5 mm**

Profilu augstums: **87 mm**

**T135**

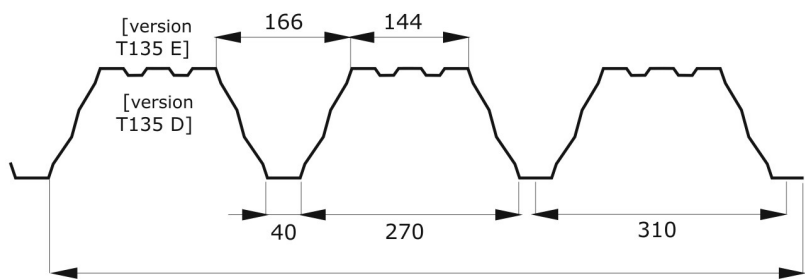
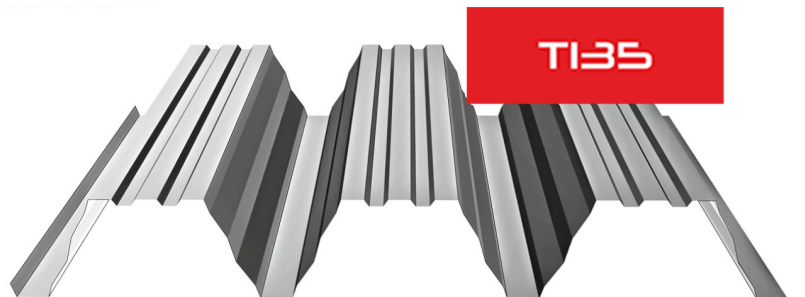

Efektīvnā platumā: **930 mm**

Platumā: **~964 mm**

Maximālā ieteicamā plāksnes garums: **14 000 mm**

Plāksnes biezums: **0,7 - 1,5 mm**

Profilu augstums: **135 mm**

**T153**

powłoka dekoracyjna



Wersja [T153E]



Wersja [T153D]

powłoka dekoracyjna

Efektīvnā platumā: **840 mm**

Platumā: **~880 mm**

Maximālā ieteicamā plāksnes garums: **14 000 mm**

Plāksnes biezums: **0,7 - 1,5 mm**

Profilu augstums: **153 mm**

powłoka dekoracyjna

**T160**



Wersja [T160E]

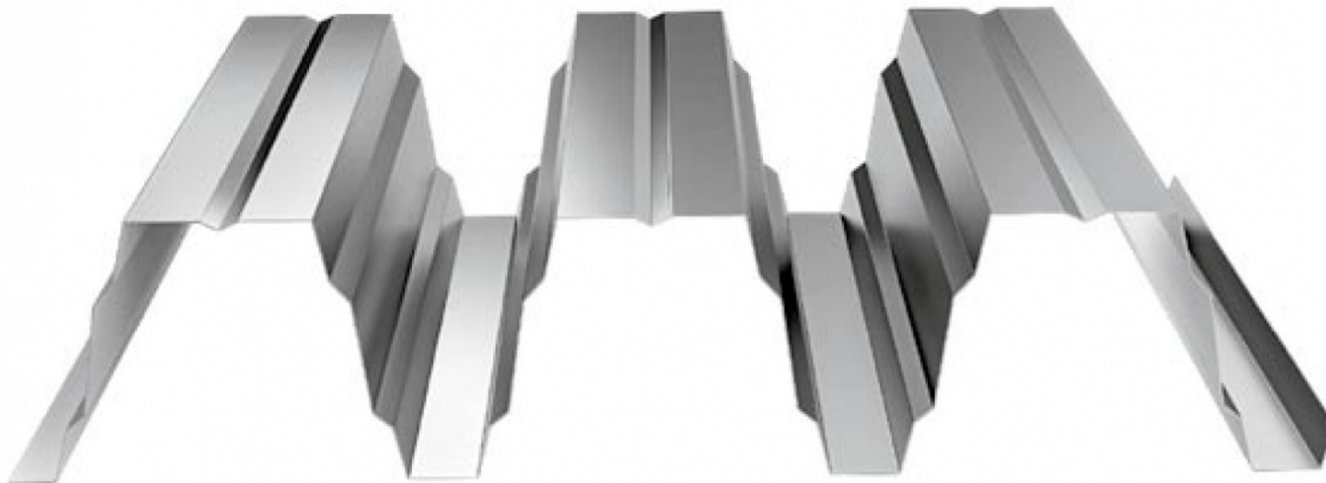

Wersja [T160D]

powłoka dekoracyjna

Efektívne laius: **750 mm**

Laius: **790 mm**

Max soovitatav lehe **14 000 mm**  
pikkus:

Pleki paksus: **0,75 - 1,5 mm**

Profiili kõrgus: **161,6 mm**

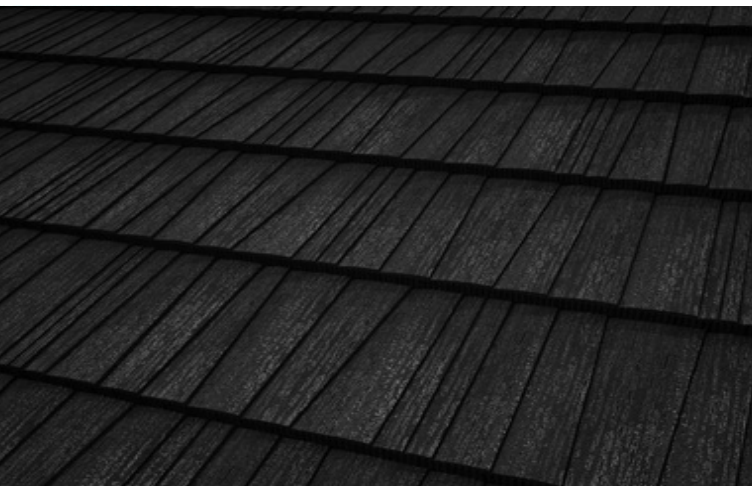

Laius:	<b>1222 mm</b>
Efektívne laius:	<b>1170 mm</b>
Profiili kõrgus:	<b>6 mm</b>
Pleki paksus:	<b>0,5 mm</b>
Kiviriba laius:	<b>35 mm</b>
Kiviriba kõrgus:	<b>380 mm</b>
Moodulite arv ruutmeetri kohta:	<b>2,247/m<sup>2</sup></b>

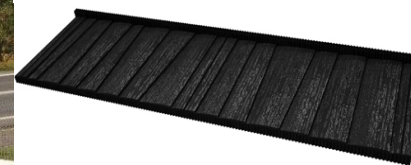

Inguri®

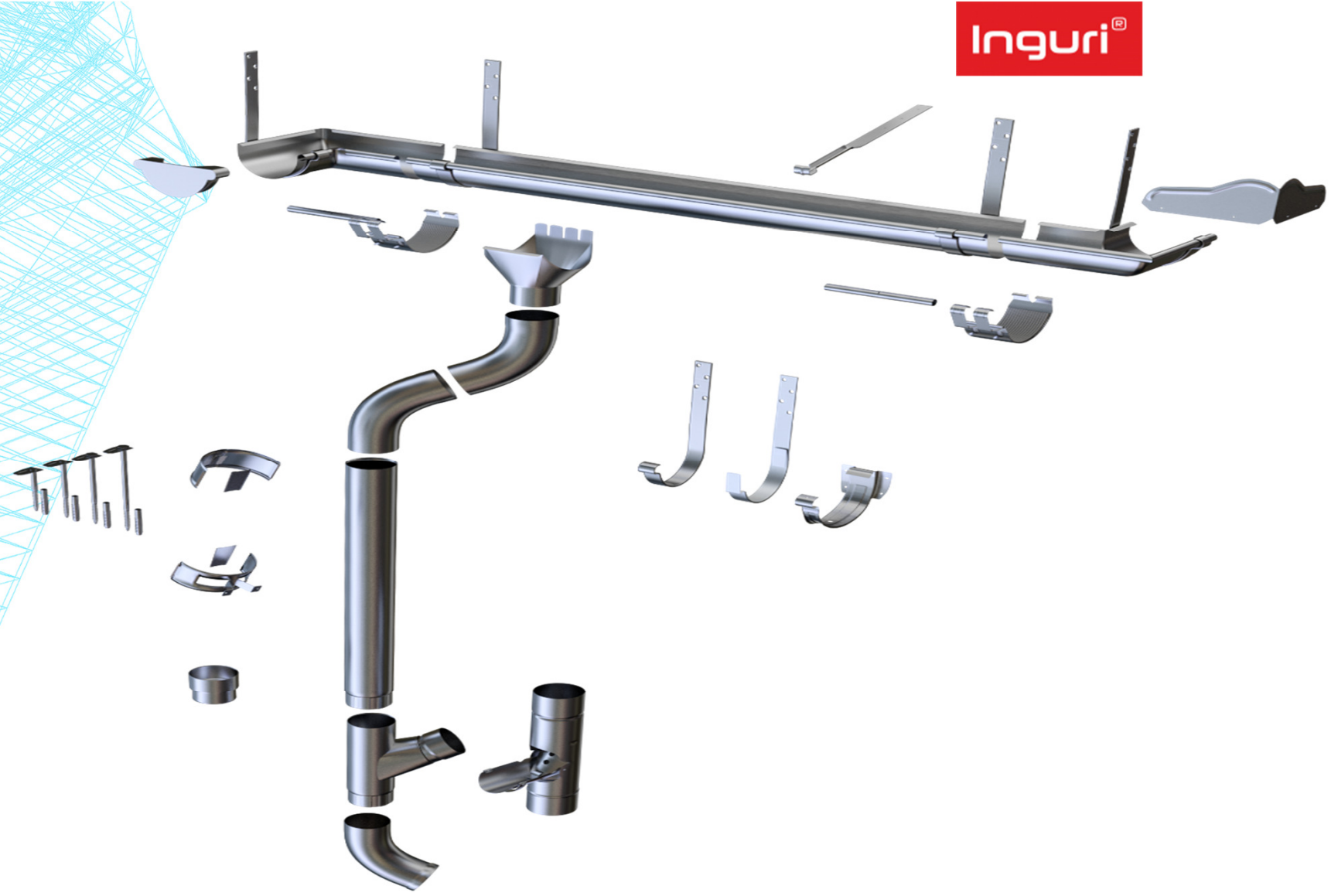

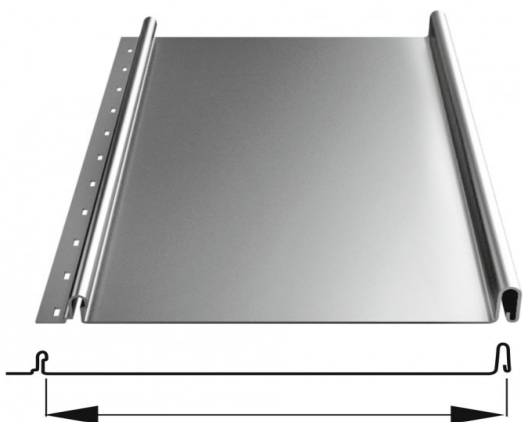

effective width 205 mm

**L25.205P**  
**LW25.205P**  
**LWZ25.205P**

Valtsi kõrgus: **25 mm**

Efektiivne laius: **515 mm; 306 mm;**  
**205 mm**

Laius: **~547 mm; ~337 mm;**  
**~236 mm**

Pleki paksus: **0,5 mm**

Lehe pikkus: **8 000 mm**

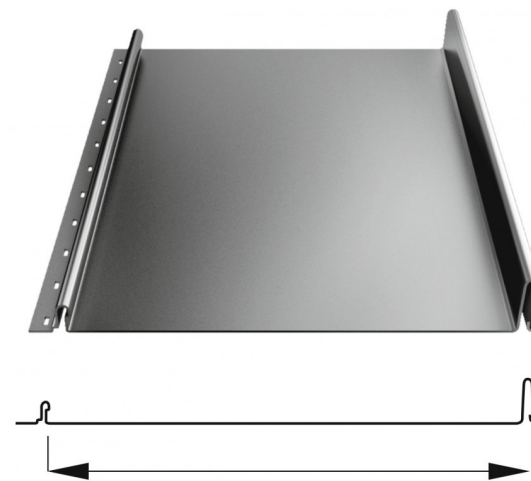

effective width 283 mm

**L38.283P**  
**LW38.283P**  
**LWZ38.283P**

Valtsi kõrgus: **38 mm**

Efektiivne laius: **490 mm; 283 mm**

Laius: **~522 mm; ~314 mm**

Pleki paksus: **0,5 - 0,7 mm**

Lehe pikkus: **10 000 mm**

# ELEVATION CASSETTES AND PANELS

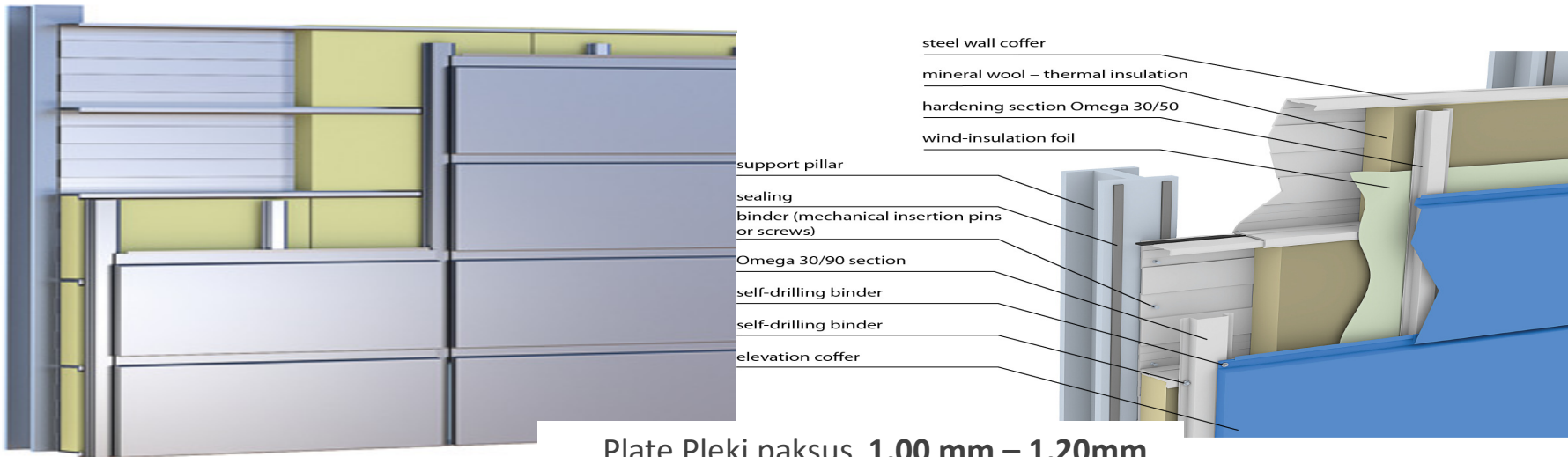

Plate Pleki paksus **1,00 mm – 1,20mm**  
range

Cladding length **from 240 mm to 3000 mm**

Cladding width **from 265 mm to 800 mm**

Binding horizontal **from 10 mm to 30 mm**  
width

Binding vertical width **from 10 mm to 30 mm**

Pleki paksus (depth) **25 mm or 30 mm**

Cross-section - horizontal binding

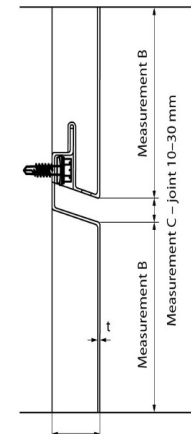

Cross-section - vertical binding

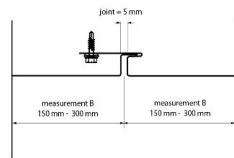
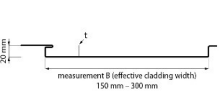
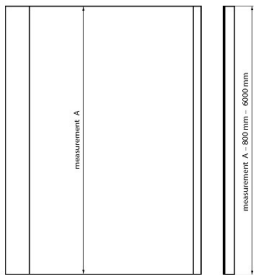
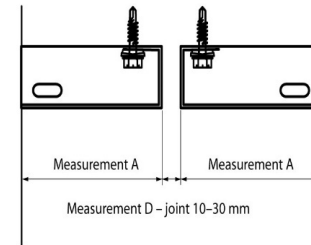

Measurement G - 25 mm or 30 mm

## FIREWALL 90 MINUTES . PROSYSTHERM

